



# OFF-THE-ROAD

## Disc Brake Pads Applications and Illustrations



### OTR102

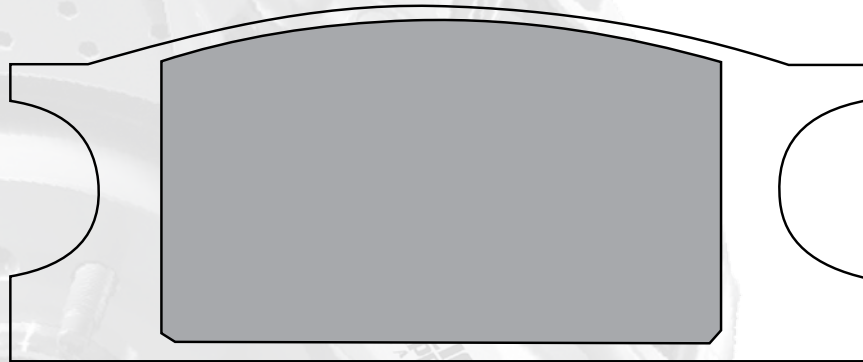

### OTR103

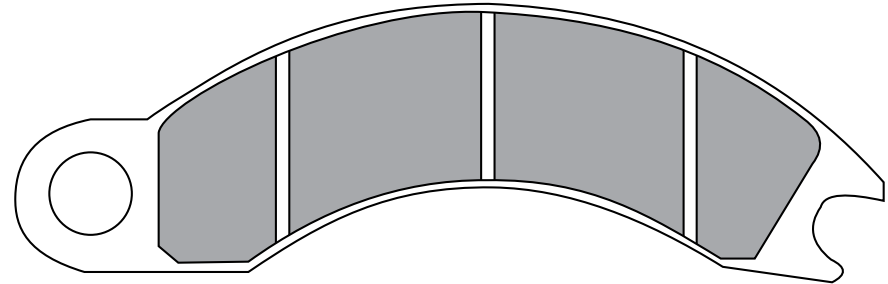

281

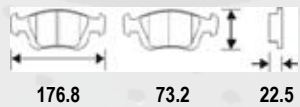

CATERPILLER 920, CASE W14, JCB 423,  
FURUKAWA F1330

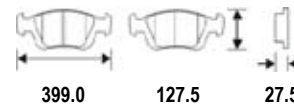

CATERPILLER 950B,  
EUCLID,  
MOXY,  
KOMATSU



# OFF-THE-ROAD

## Disc Brake Pads Applications and Illustrations



### OTR104

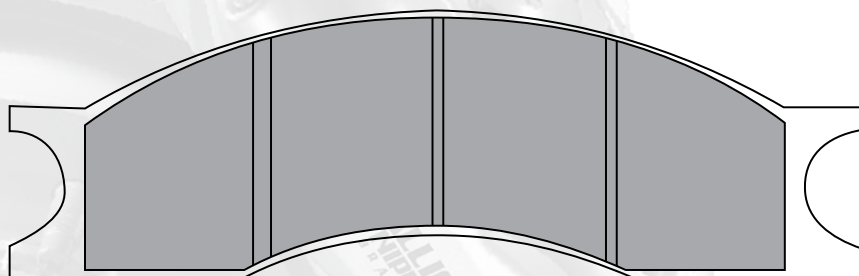

### OTR105

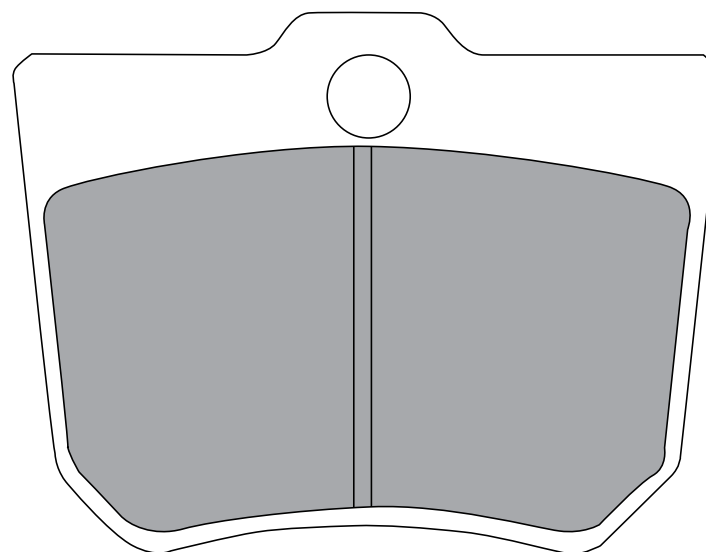

282



CAERPILLER 250, 505, 511, 521, 521A, 531, 930,  
 950,  
 CLARKE-MICHIGAN 45,50,75,125,175,DJB M25/635,  
 DJB M25/673,  
 FAUN FK20, FK1000,

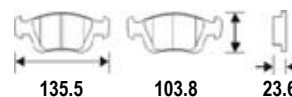

FRISCH FL400, FL300C,  
 HANOMAG 44,66,IHC540, MF 44C, 55C, 65, 66C,  
 40C.



# OFF-THE-ROAD

## Disc Brake Pads Applications and Illustrations



### OTR106

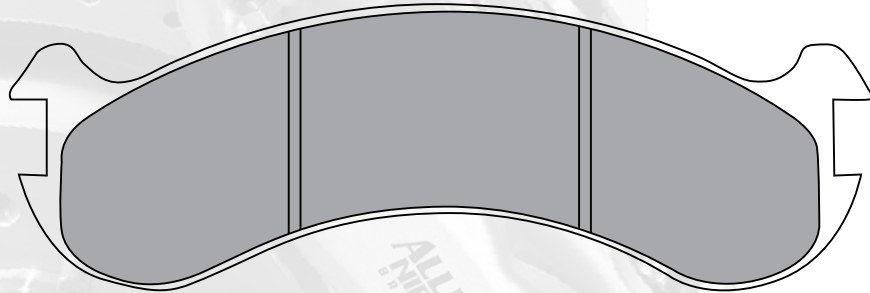

### OTR107

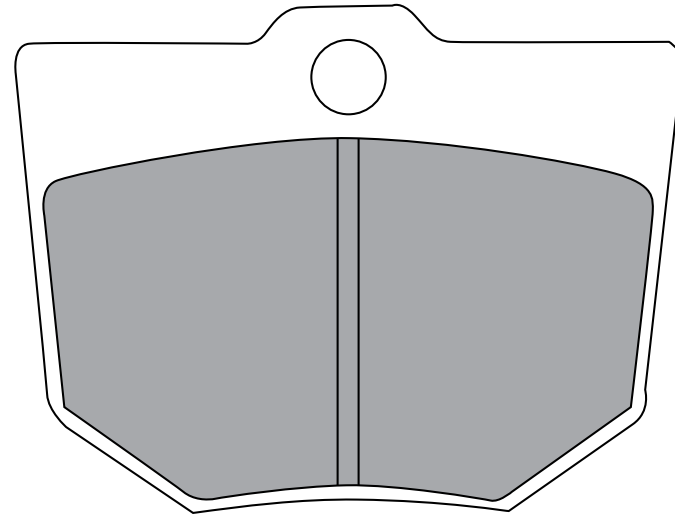

283



KOMATSU,  
MARATHON.  
MOXY,  
TEREX,  
VOLVO,

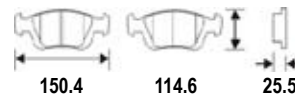

HANOMAG 44, 66,  
LIEBHER 1025 LTM, 1030, MF  
PERLINI 121-27, 131-30, 131-33  
PERROT BRAKES



# OFF-THE-ROAD

## Disc Brake Pads Applications and Illustrations



### OTR108

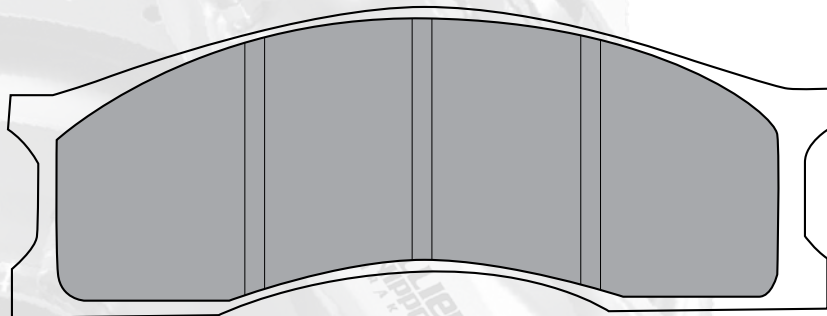

### OTR116

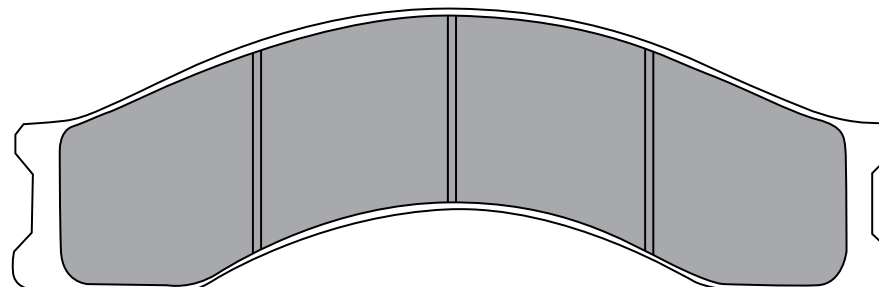

284



CATERPILLER,  
 CLARKE-MICHIGAN 45B, 50B, 75B, 125B, 175B  
 HAULAMATIC,  
 VOLVO BM 5350, 4400, 4300, 4500, 4600,

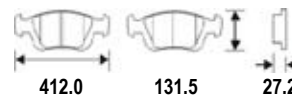

AVELING BARFORD,  
 EUCLID,  
 DRESSER  
 MICHIGAN,



# OFF-THE-ROAD

## Disc Brake Pads Applications and Illustrations



### OTR121

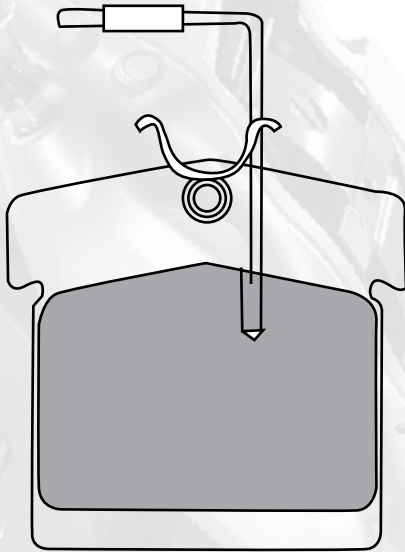

### OTR122

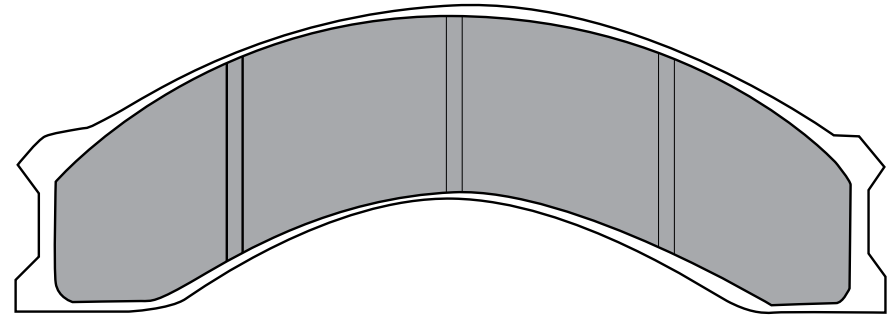

285

RENAULT TRACTOR



AVELING BARFORD

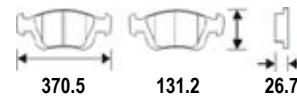



# OFF-THE-ROAD

## Disc Brake Pads Applications and Illustrations



### OTR129

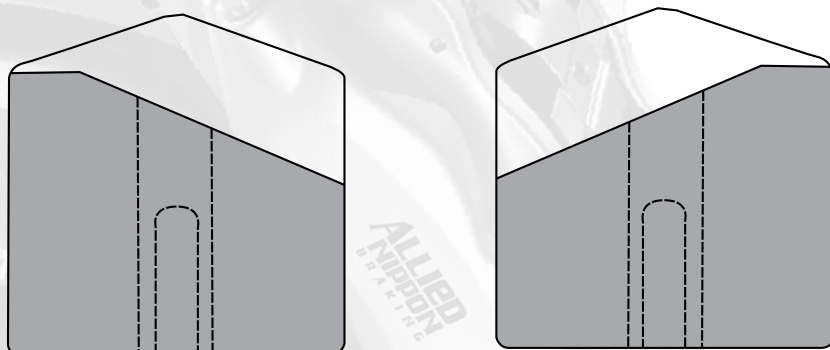

### OTR129/1

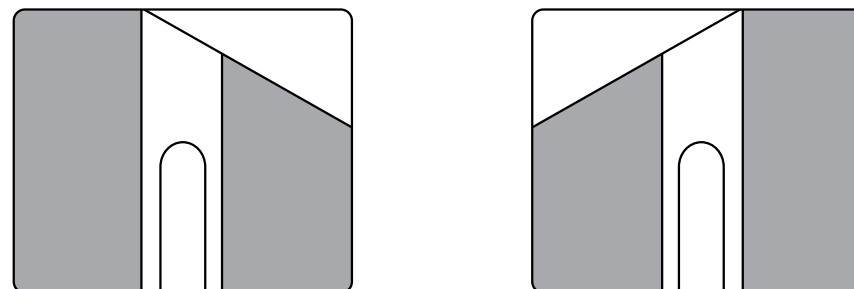

286



ALLIS CHALMERS,  
AVELING BARFORD,  
BENFORD BC NSOR,  
JCB,  
JONSON,

MATBRO,  
THWAITES,  
WEATHERHILL,  
WINGET



ALLIS CHALMERS,  
AVELING BARFORD,  
BENFORD BC NSOR,  
JCB,  
JONSON,

MATBRO,  
THWAITES,  
WEATHERHILL,  
WINGET



# OFF-THE-ROAD

## Disc Brake Pads Applications and Illustrations



### OTR129/2

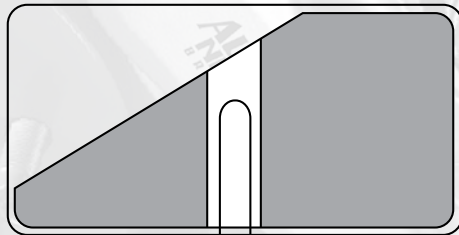
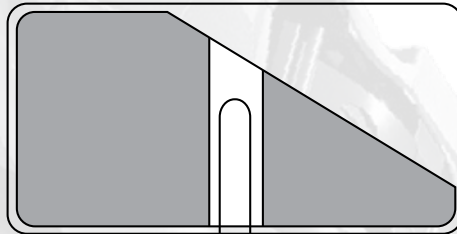

### OTR140

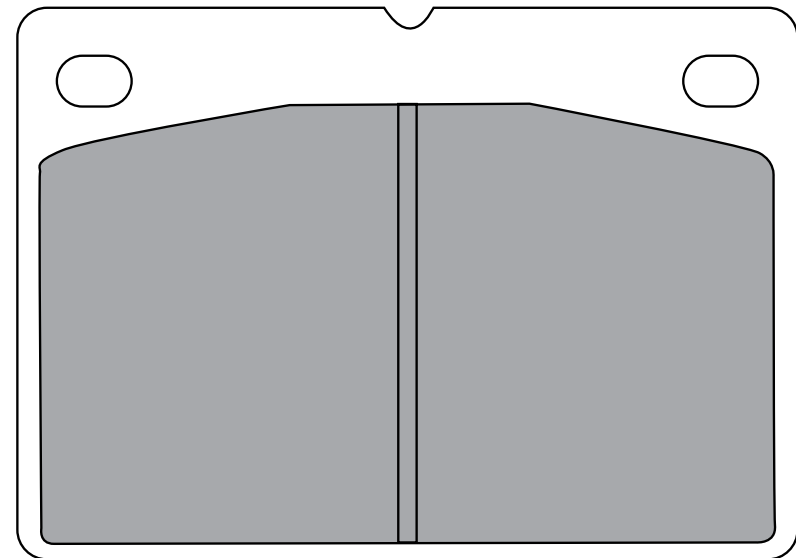

287



ALLIS CHALMERS,  
AVELING BARFORD,  
BENFORD BC NSOR,  
JCB,  
JONSON,

MATBRO,  
THWAITES,  
WEATHERHILL,  
WINGET

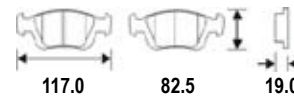

BENATI GRAB,  
HAUL,  
JCB FAST TRACK  
ROSSI,

TIMBER,  
VALMET,



# OFF-THE-ROAD

## Disc Brake Pads Applications and Illustrations



### OTR147

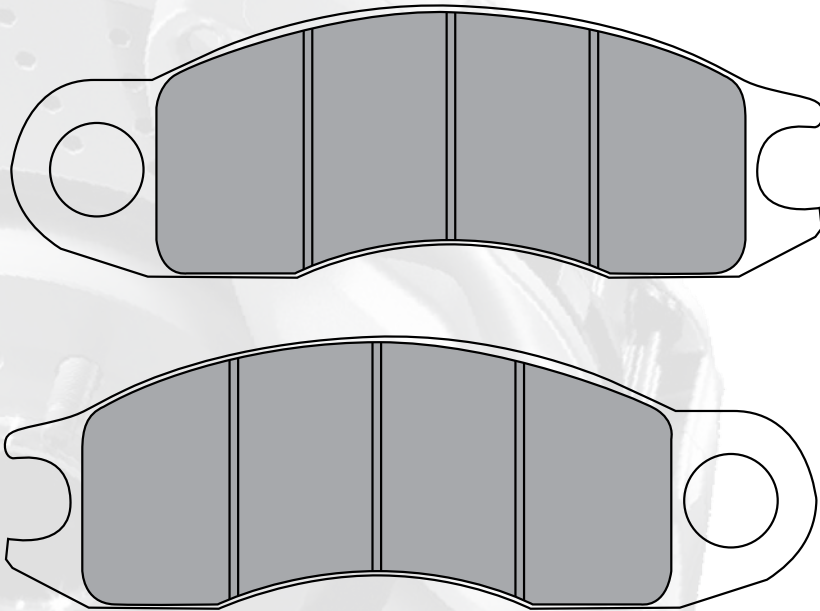

### OTR148

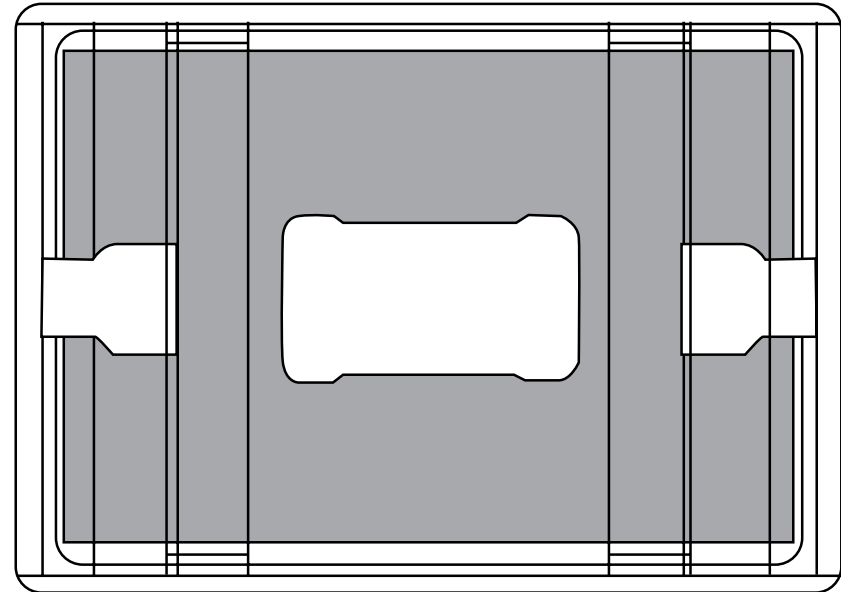

288



CASE,  
MICHIGAN  
TEREX,



HANOMAG,  
MASSY FERGUSON,  
O & K, V.M.E.  
ZETTELMAYER





# OFF-THE-ROAD

## Disc Brake Pads Applications and Illustrations



### OTR149

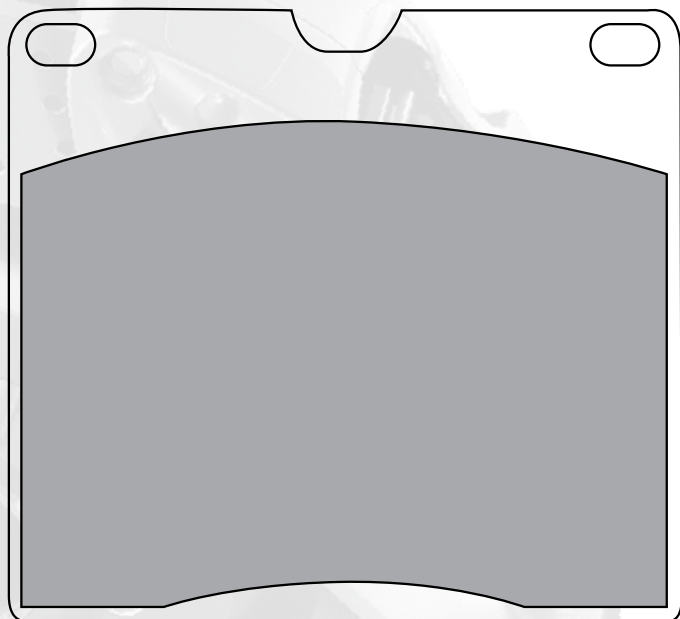

### OTR150

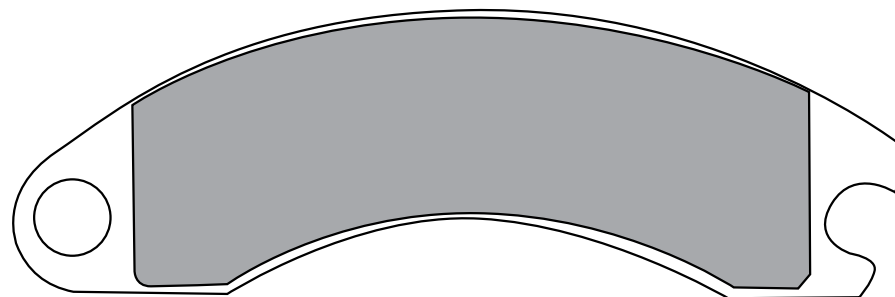

289

VOLVO VME 150



AVELING BARFORD,  
TEREX





# OFF-THE-ROAD

## Disc Brake Pads Applications and Illustrations



### OTR152

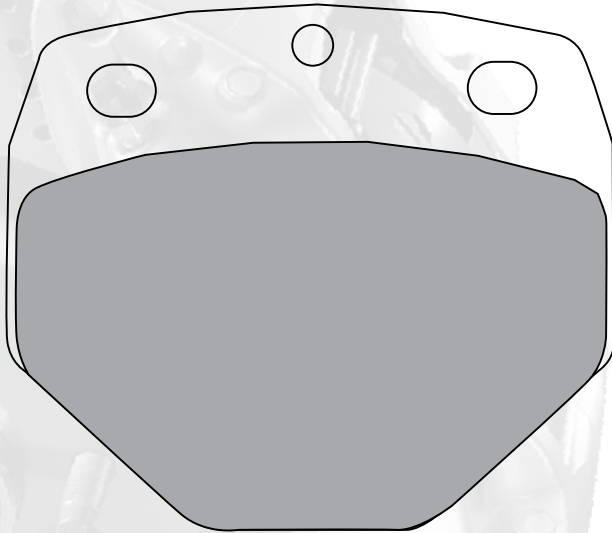

### OTR156

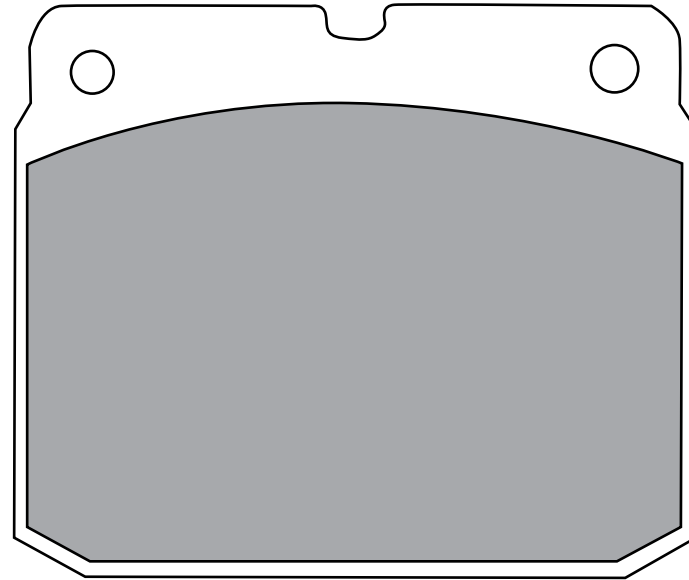

290

VOLVO A35, A40

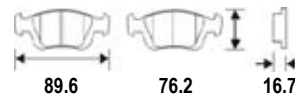

AVELING BARFORD,  
JCB FAST TRACK,  
SANDERSON MACHINES,  
WINDMILLS



# OFF-THE-ROAD

## Disc Brake Pads Applications and Illustrations



### OTR158

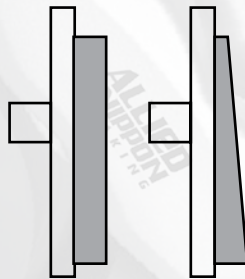
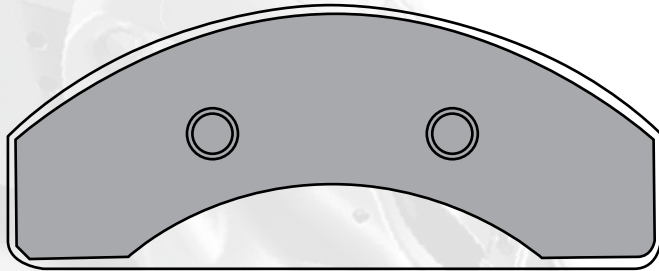

### OTR161

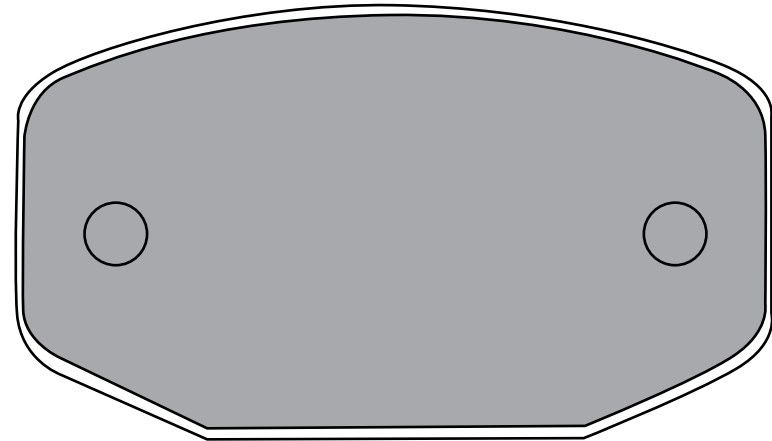

291

**MASSY FERGUSON,  
VINEYARD TRACTOR**



**VOLVO A35 HANDBRAKE**

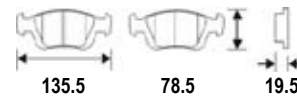



# OFF-THE-ROAD

## Disc Brake Pads Applications and Illustrations



### OTR170

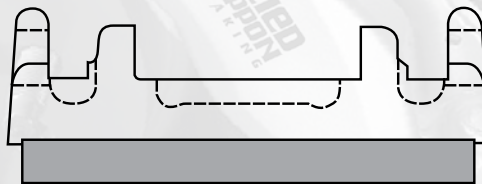
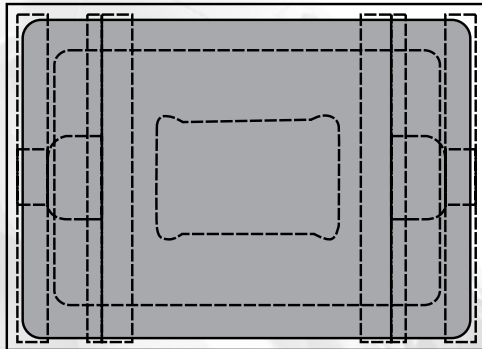

### OTR177

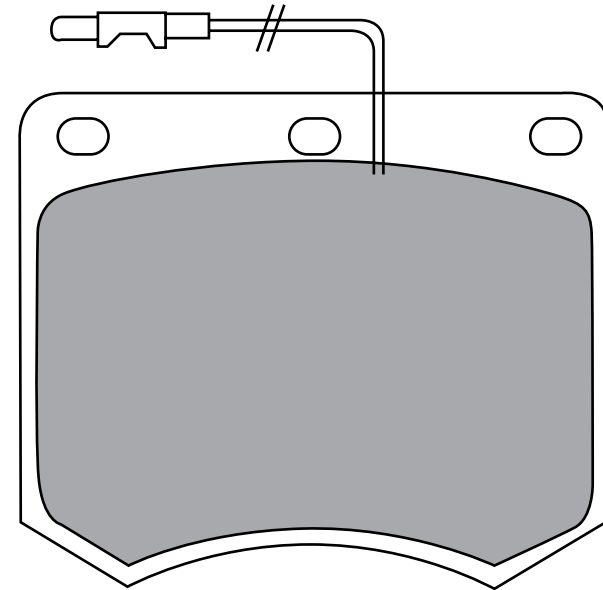

292



HANOMOG,  
 MASSY FURGUSON,  
 V.M.E. (HANDBRAKE)

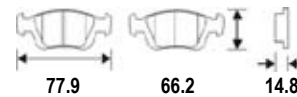

CASE 1455 PROSHAFT PAD,  
 FENDT 600 PROSHAFT PAD



# OFF-THE-ROAD

## Disc Brake Pads Applications and Illustrations



### OTR179

### OTR179/1

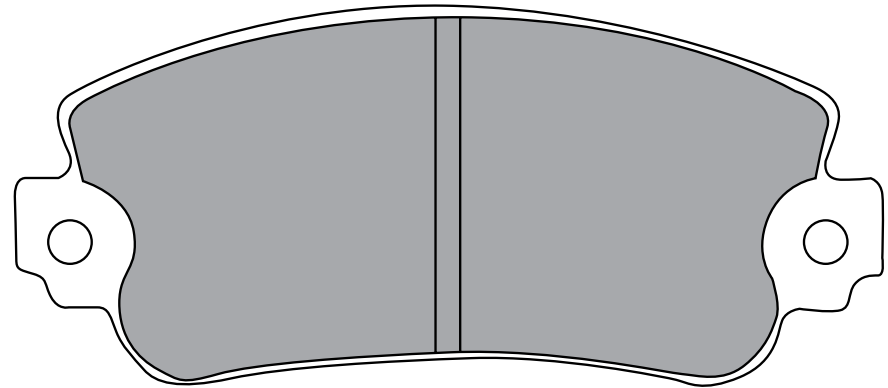
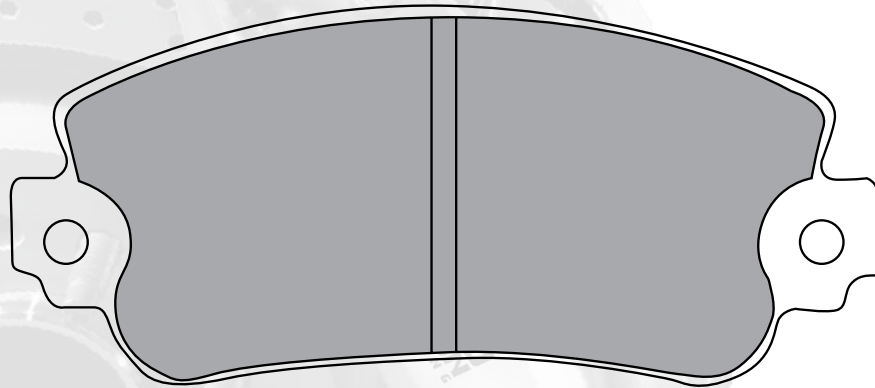

MERLOT FORK LIFT TRUCK

MERLOT FORK LIFT TRUCK

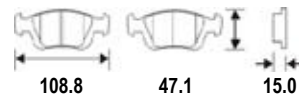

293



# OFF-THE-ROAD

## Disc Brake Pads Applications and Illustrations



### OTR179/2

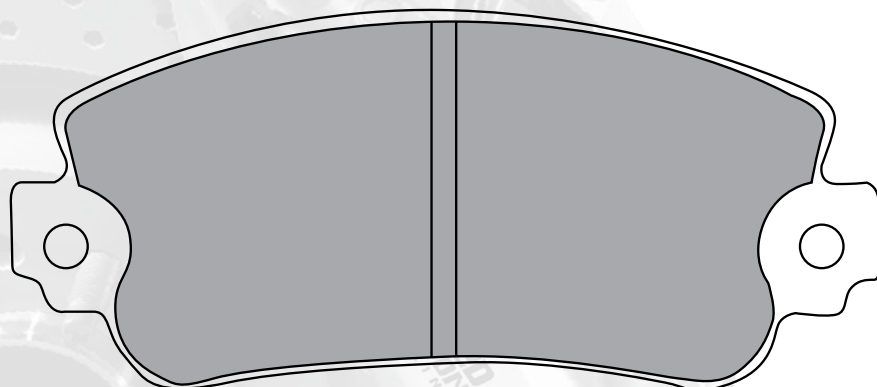

### OTR180

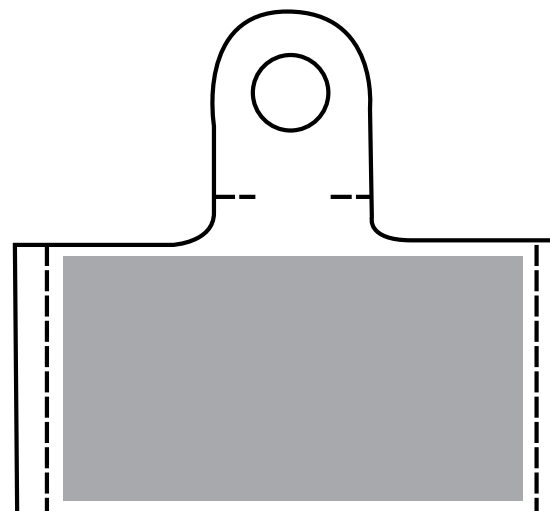

294

MICRO CALIPER 29060015

TWYFLEX PAD

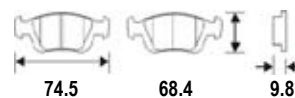



# OFF-THE-ROAD

## Disc Brake Pads Applications and Illustrations



### OTR184

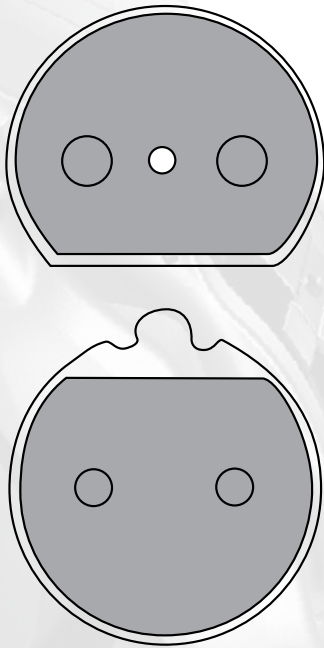

### OTR186

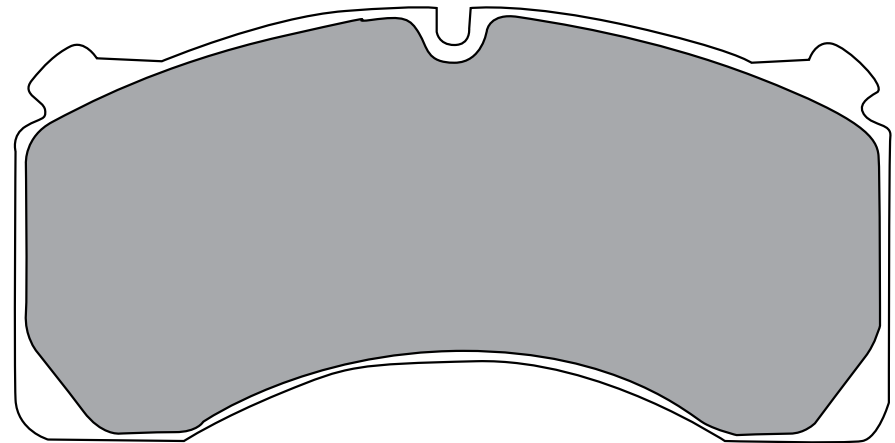

295

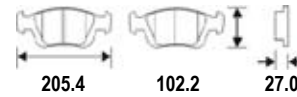

MERITOR / ROR : DX195 19.5"



# OFF-THE-ROAD

## Disc Brake Pads Applications and Illustrations



### OTR188

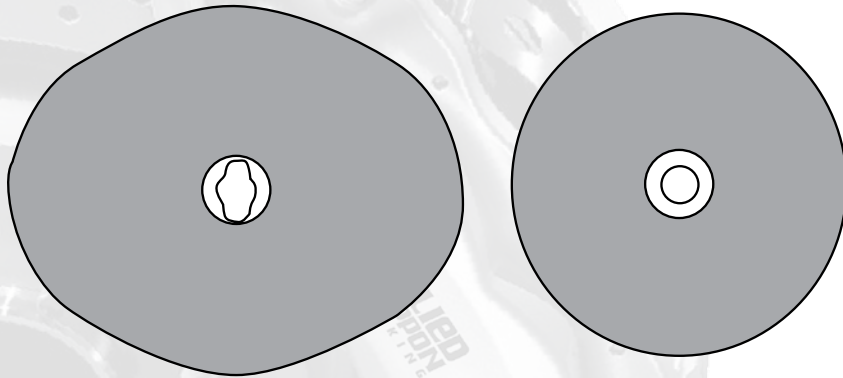

### HVR001

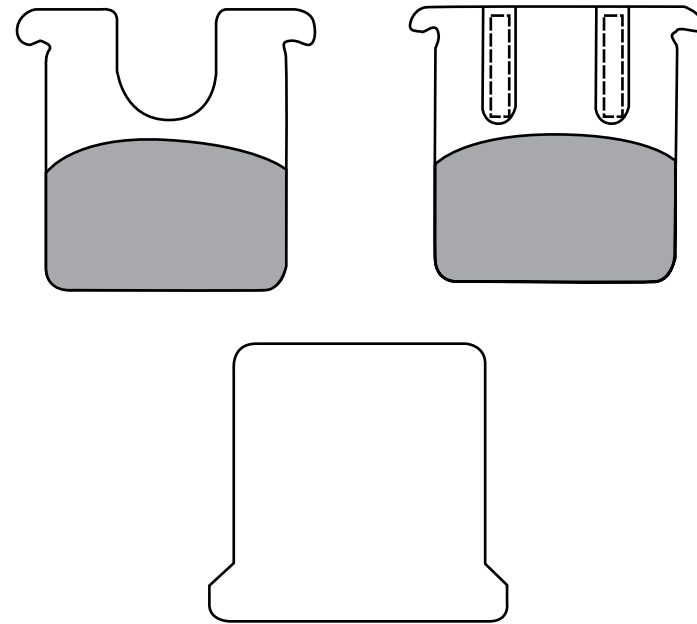

296

